

1/2" ODS (Cu)

1" UN

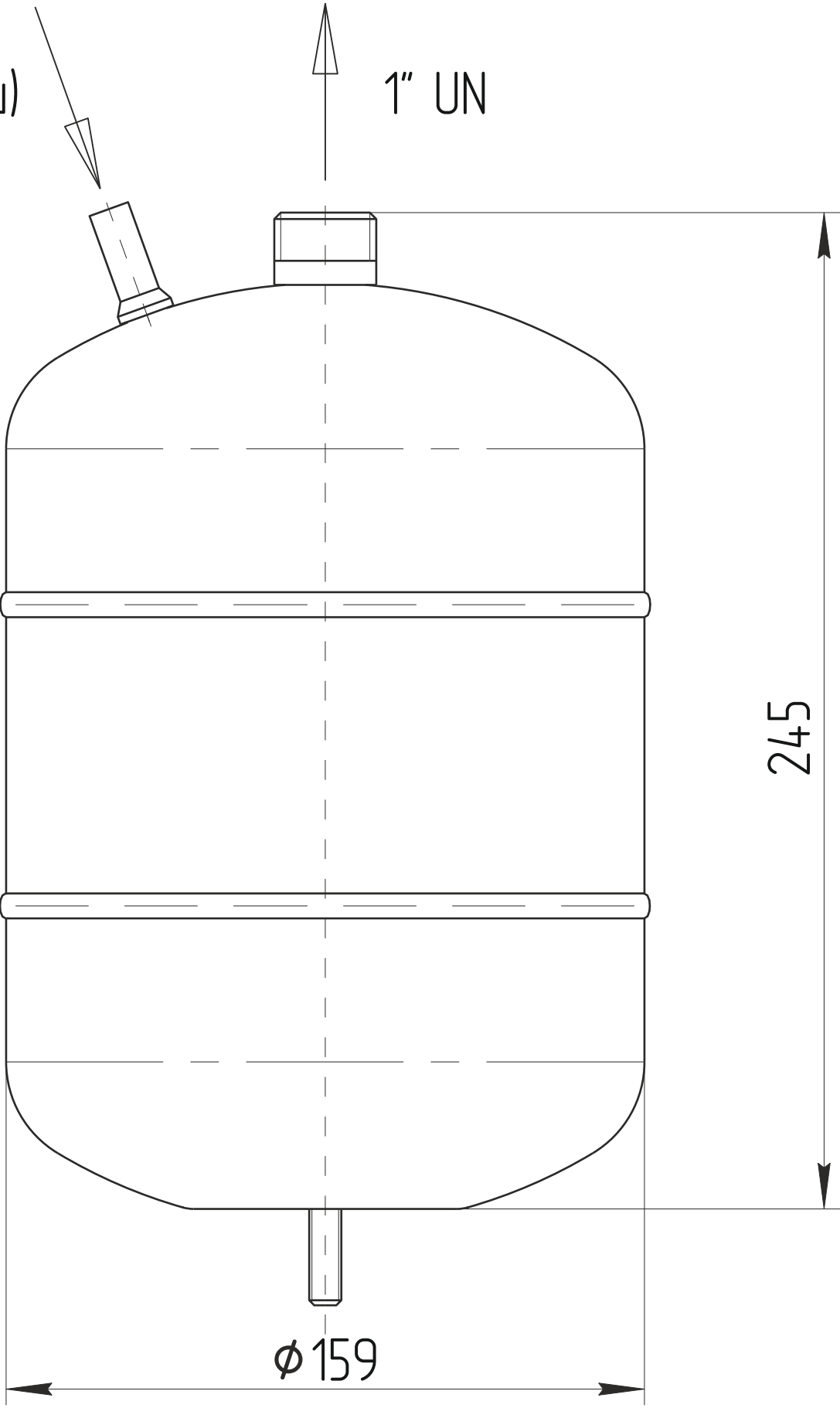

245

$\phi 159$